

The MetaNeb® System

User Manual

Product No. PMN4



RxOnly
(USA)



Enhancing outcomes for
patients and their caregivers:

Hill-Rom

REVISION

© 2018 by Hill-Rom Services PTE Ltd. ALL RIGHTS RESERVED.

PATENTS / PATENT www.hill-rom.com/patents

The MetaNeb® System may be covered by one or more patents. See the Internet address above.

The Hill-Rom companies are the proprietors of European, US, and other patents and pending patent applications.

Manufactured by:

HILL-ROM SERVICES PRIVATE LIMITED
1 YISHUN AVENUE 7
SINGAPORE 768923

Authorized European Union Representative:

REGULATORY AFFAIRS REPRESENTATIVE
WELCH ALLYN LIMITED
NAVAN BUSINESS PARK
DUBLIN ROAD
NAVAN, COUNTY MEATH,
REPUBLIC OF IRELAND

Authorized Brazilian Representative:

VR MEDICAL—MEDICAL DEVICES IMPORTER & DISTRIBUTOR, LTDA.
391 BATATAES STREET
CJ 11-13, 8TH FLOOR
SÃO PAULO, SP-BRAZIL
CNPJ: 04.718.143/0001-94

No part of this text shall be reproduced or transmitted in any form or by any means, electronic or mechanical, including photocopying, recording, or by any information or retrieval system without written permission from Hill-Rom Services, Inc. (Hill-Rom).

The information in this manual is confidential and may not be disclosed to third parties without the prior written consent of Hill-Rom.

The information in this manual is subject to change without notice. Hill-Rom makes no commitment to update or keep current, the information in this manual.

Hill-Rom reserves the right to make changes without notice in design, specifications, and models. The only warranty Hill-Rom makes is the express written warranty extended on the sale or rental of its products.

This manual (174432) was originally released and supplied in English. For a list of available translations, contact Hill-Rom Technical Support.

Product images and labels are for illustrative purposes only. Actual product and label may vary.

Eighth Edition, November 2018

First Printing, 2013

Hill-Rom® is a registered trademark of Hill-Rom Services, Inc.

MetaNeb® and MetaTherapy® are registered trademarks of Comedica, Inc.

Replace this manual (174432) if it is damaged and/or can not be read.

For product support or to order additional copies of this manual (174432), contact your distributor, local Hill-Rom representative, or go to www.hill-rom.com.

Reference Documents

MetaNeb® System Service Manual, International (187293)

MetaNeb® System Service Manual, North America (174508)

183808/206962 Stand Assembly Instructions (182920)

Stand (M08183) Assembly Instructions (207981)

Table of Contents

Revision	i
Document Symbols.....	1
Indications	1
Indications for Use.....	1
Patient Population.....	1
Absolute Contraindications	1
Relative Contraindications	1
Possible Adverse Reactions	2
Precautions	2
Introduction.....	3
Description.....	3
Theory of Operation	4
Normal Mucus Clearance	4
Mucociliary Escalator	4
Cough	4
Autocephalad Flow	4
The MetaNeb® System and Bronchial Hygiene.....	5
Features.....	7
Controller	7
Circuit.....	8
Assemble the Controller System.....	9
Stand Assembly and Controller Installation.....	9
Installation of 183808 and 207384 Stands	9
Installation of M08183 Stand	10
Connect the Oxygen Hose	12
Assemble the Circuit.....	12
Typical Mouthpiece Configuration	12
Other Configurations	13
Add Medication to the Nebulizer.....	14
Pre-Use Check	15
Pre-Use Check For In-Line Use with a Ventilator.....	16
MetaTherapy® Treatment Protocol	17
Frequency.....	17
Procedure.....	17

Assessment of Outcome.....	18
Re-Evaluation	18
The MetaNeb® System In-Line with Ventilator Protocol	19
Frequency	19
Procedure	19
Assessment of Outcome.....	20
Re-Evaluation	20
Move the Stand	21
Cleaning	21
Cleaning the Controller and Stand.....	22
Cleaning the Circuit	22
Troubleshooting and Maintenance.....	24
Troubleshooting	24
Maintenance.....	25
Shipping and Packaging.....	25
Product symbols	26
Specifications	28
Controller Dimensions.....	30
Stand Dimensions (183808 and 207384)	31
Stand Dimensions (M08183).....	32
Classification and Standards.....	33
Technical Specification for Performance—Breathing Simulator ...	34
CHFO Pulses—Airway Pressure Reading	35
CPEP—Airway Pressure Reading.....	35
Hi Pressure CHFO Pulses—Airway Pressure Reading.....	36
Hi Pressure CPEP—Airway Pressure Reading	36
Bench Performance Checks—Breathing Simulator.....	37
Nebulizer Performance	41
Circuit Part Numbers	41
Particle Specifications	42

DOCUMENT SYMBOLS

This manual contains different typefaces and symbols to make the content easier to read and understand:

- Standard text—used for regular data.
- **Boldface text**—emphasizes a word or phrase.
- **NOTE:**—sets apart special data or important instruction clarification.
- WARNING or CAUTION



- A WARNING identifies situations or actions that may have an effect on patient or user safety. To ignore a warning could cause patient or user injury.
- A CAUTION identifies special procedures or precautions that persons must obey to help prevent equipment damage.

INDICATIONS

INDICATIONS FOR USE

The MetaNeb® System is indicated for mobilization of secretions, lung expansion therapy, the treatment and prevention of pulmonary atelectasis, and also has the ability to provide supplemental oxygen when used with compressed oxygen.

PATIENT POPULATION

- Adults and children over the age of 2

ABSOLUTE CONTRAINDICATIONS

- Untreated tension pneumothorax
- Untrained or unskilled operator

RELATIVE CONTRAINDICATIONS

- History of pneumothorax
- Pulmonary air leak
- Recent pneumonectomy
- Pulmonary hemorrhage
- Myocardial infarction
- Vomiting

POSSIBLE ADVERSE REACTIONS

- Hyperventilation
- Gastric distension
- Decreased cardiac output
- Increased intracranial pressure
- Increased air trapping
- Hyperoxygenation
- Pneumothorax
- Pulmonary air leak
- Pulmonary hemorrhage

PRECAUTIONS

- Federal law restricts this device to sale by or on the order of a physician.
- Circuits are for single patient use, multiple treatment sessions.
- Do not occlude entrainment orifices.
- Do not use on uncooperative patients.
- Read the User Manual before use.
- Use only with the supplied nebulizer.
- To be used only by individuals familiar with its use.
- Failure to discard the circuit in accordance with facility protocol could cause patient injury due to cross-contamination.
- Care should be taken to appropriately suction secretions as they mobilize into the upper airways.
- Use only with hospital grade 50 psi oxygen sources that meet local, state, and government regulations.
- Continuous Positive Expiratory Pressure (CPEP) is a therapy and is never to be used for life support.
- Monitor the patient, patient lines, and circuit lines during therapy and/or bed articulation.
- Make sure you connect the nebulizer to the nebulizer tubing **only**.
- Only persons trained to use The MetaNeb® System and ventilators should perform therapy on ventilated patients.
- Unlock the brake casters during transport. Lock the brake casters during therapy or when not being transported.
- Let the unit stabilize to room conditions for 1 hour after storage or transport in a cold or humid environment.

- Keep away from all ignition sources.
- Do not use near flammable anesthetics.
- This device is not suitable for use with anesthetic breathing systems.
- This product contains chemicals known to the State of California to cause cancer and birth defects or other reproductive harm.

INTRODUCTION

The MetaNeb® System supplies a therapy that enhances secretion removal and helps prevent or resolve patchy atelectasis.

DESCRIPTION

The MetaNeb® System is a therapeutic device that uses a systematic approach to enhance normal mucus clearance and resolve or prevent patchy atelectasis.

The system has three modes:

- CHFO (Continuous High Frequency Oscillation)—a pneumatic form of chest physiotherapy that delivers medicated aerosol while oscillating the airways with continuous pulses of positive pressure.
- CPEP (Continuous Positive Expiratory Pressure)—supplies medicated aerosol combined with continuous positive pressure to help hold open and expand the airways.
- Aerosol—for the delivery of aerosol only. In this mode CHFO and CPEP are not available.

The MetaNeb® System supplies a platform from which both CHFO and CPEP can be administered contiguously. This composite therapy is referred to as “MetaTherapy® Treatment.” MetaTherapy® Treatment is a combination therapy that seamlessly alternates between CPEP and CHFO modes. CPEP is a therapy and is never to be used for life support.

There are three major components to The MetaNeb® System:

- Circuit—includes a mouthpiece, handset, nebulizer, tubing, and circuit tri-connector/bio-filter. It is a single patient use, latex-free assembly that is intended for multiple treatment sessions.
- Controller—contains the controls to select the three different modes. It also has a manometer to monitor pressure. Power is supplied by a hose connected to a minimum 50 psi oxygen source.

- Stand—lets you easily move The MetaNeb® System from room to room.

THEORY OF OPERATION

Normal Mucus Clearance

Normal mucus clearance in the lungs is accomplished in three unique ways. It must be understood that these mechanisms complement each other and none are mutually exclusive. The three mechanisms are:

1. Mucociliary Escalator
2. Cough
3. Autocephalad Flow

Mucociliary Escalator

The respiratory tract consists of approximately twenty-four generations, each lined with a mucus secretion that has two layers. The top layer is a hydrated gel layer. The bottom layer is a thin, less viscous sol layer. Cilia line the entire surface of the respiratory tract down to the terminal bronchiole (16th generation). These cilia beat continuously at a rate of approximately 10-20 times per second and propel mucus in a cephalad fashion 1-3 mm per second. The mucus with any entrapped particles is swallowed or coughed to the atmosphere.

Cough

A cough can be voluntary or stimulated as part of a reflex and is an effective way to remove even large quantities of secretions from the upper airways (6th-7th generations). This is accomplished by creating high velocity flow rates at high lung volumes through the generation of intrapleural pressures >100 mmHg, then releasing this pressure explosively to the atmosphere. Air can be expelled in excess of 100 miles per hour. These high airflows create shear forces, which in turn, cause mucus to be expelled. Past the 6th generation, airways begin to lose their cartilaginous support, and at the high pressures the small airways tend to collapse, which prevents secretion removal. Thus, the rationale behind the HUFF cough and FET maneuvers is that when you teach patients to cough at lower lung volumes, high pressures are minimized and small airway collapse is reduced.

Autocephalad Flow

When gas flows over a thickly lined mucus layer, a shear force directly proportional to the velocity of the gas is produced. If this airflow velocity is maintained and exceeds the cohesive forces of the mucus, the mucus will move in the direction of the gas flow. Essentially, autocephalad flow is

comparable to a cough, except that lower gas velocities are generally present. To further understand, it is helpful to examine normal tidal breathing. During normal inspiration the diaphragm contracts and is displaced caudally. Concomitantly, the intercostal muscles contract to lift the ribs. These actions together increase the anterior-posterior dimension (volume) of the thoracic cavity which causes a decrease in alveolar pressure as compared to atmospheric. This pressure gradient causes a flow of gas into the lungs.

It is important to understand that as the pressure gradient rises, so do the flow rate and the velocity. The highest flow rates can be expected to be in the upper airways during inspiration because the gradient begins at the mouth and ends at the alveoli. During exhalation the process is reversed and the alveolar pressure is greater than atmospheric. The flow gradient is now from the alveoli to the mouth, and therefore, the greatest flow rates will be in the smaller airways. Since the normal I:E (inspiratory to expiratory) ratio is 1:1.5 to 1:2, secretions from these airways are transported to the larger airways by way of asymmetric periodic gas flow.

The MetaNeb® System and Bronchial Hygiene

The MetaNeb® System supplies aerosol, CHFO, and CPEP therapy modes.

CHFO is a pneumatic form of chest physiotherapy that uses a systematic approach to enhance normal mucus clearance and resolve patchy atelectasis. CHFO—

- Supplies aerosolized medication and humidification to relax bronchial smooth muscle so that airway resistance is decreased, and at the same time hydrates thickened retained secretions.
- Uses specifically calibrated frequency and I:E ratio to create a mean airway pressure in order to maintain airway caliber, prevent premature closure, and expand collapsed lung regions.
- Maintains continuous high frequency oscillation during both inspiration and expiration to form a pressure gradient to the small airways where secretions are trapped. This pressure gradient creates an accelerated expiratory airflow that can be manipulated to help move the secretions to the upper airways.
- Aids in the mobilization of retained secretions.

CPEP is a therapy which supplies a continuous, clinician-set airway pressure above atmospheric by use of a venturi, a fixed orifice resistor, and flow during both inspiration and expiration. CPEP—

- Prevents or reverses atelectasis.
- Delivers hyperinflation therapy through positive expiratory pressure that will help patients deeply breathe and cough.
- Reduces the incidence of air trapping.

FEATURES

CONTROLLER

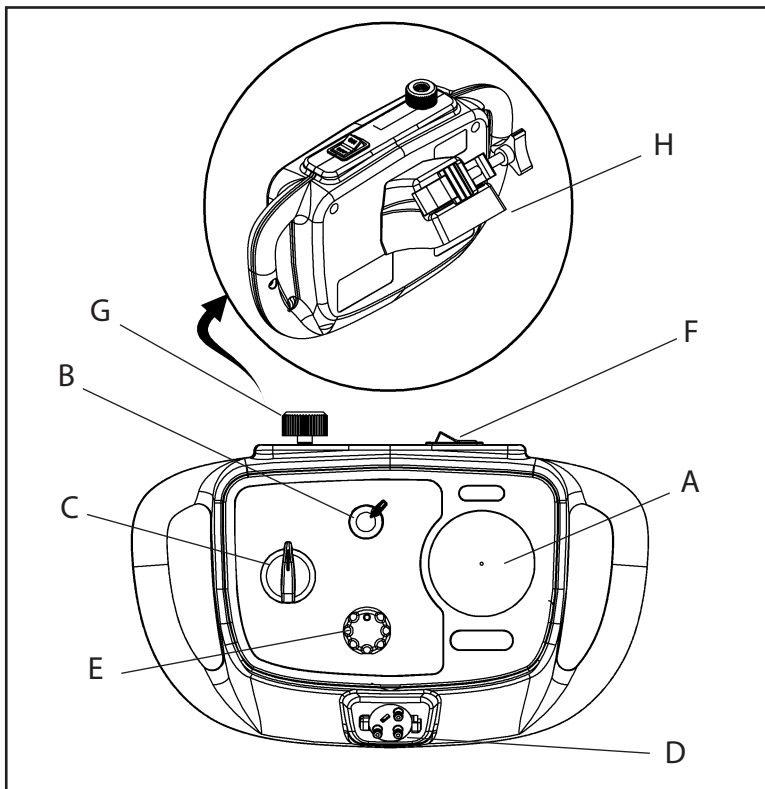

Item	Description	Item	Description
A	Pressure manometer	E	CPEP flow adjuster
B	Higher/lower switch	F	Master ON/OFF switch
C	Mode selector	G	Oxygen gas connector
D	Circuit tri-connector port	H	Mount bracket

CIRCUIT

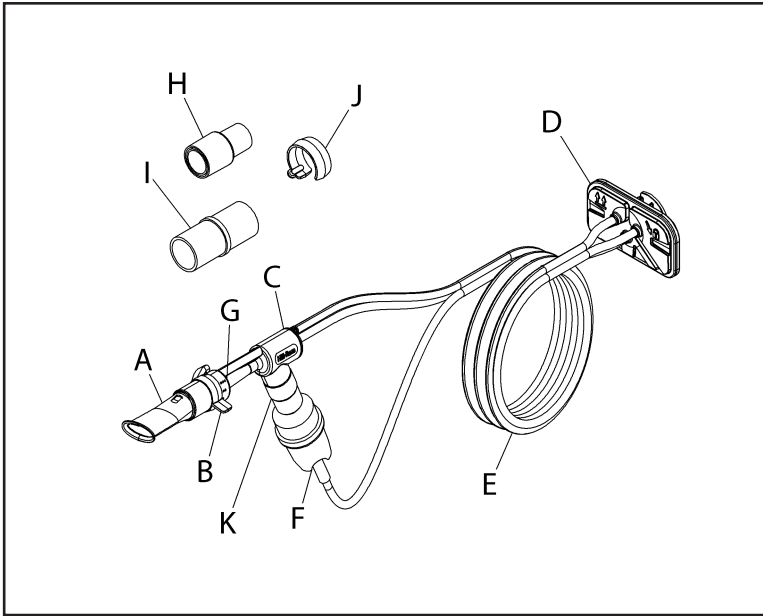

Item	Description	Item	Description
A	Mouthpiece	G	Orifice indicators
B	Selector ring	H	Adapter, 22 mm x 15 mm
C	Handset	I	Adapter, 22 mm x 22 mm
D	Circuit tri-connector/ bio-filter	J	Occlusion ring
E	Tubing	K	Silicon adapter
F	Nebulizer	L	Nebulizer tubing

ASSEMBLE THE CONTROLLER SYSTEM

Make sure you have all the parts that are listed on the contents list.

STAND ASSEMBLY AND CONTROLLER INSTALLATION

Some older devices may have a different stand. For a stand that differs from that shown, refer to the instructions that were supplied with the stand.

If a two parts pole construction is used, make sure the two parts are fully tightened to each other and there is no gap at the joint.

Installation of 183808 and 207384 Stands

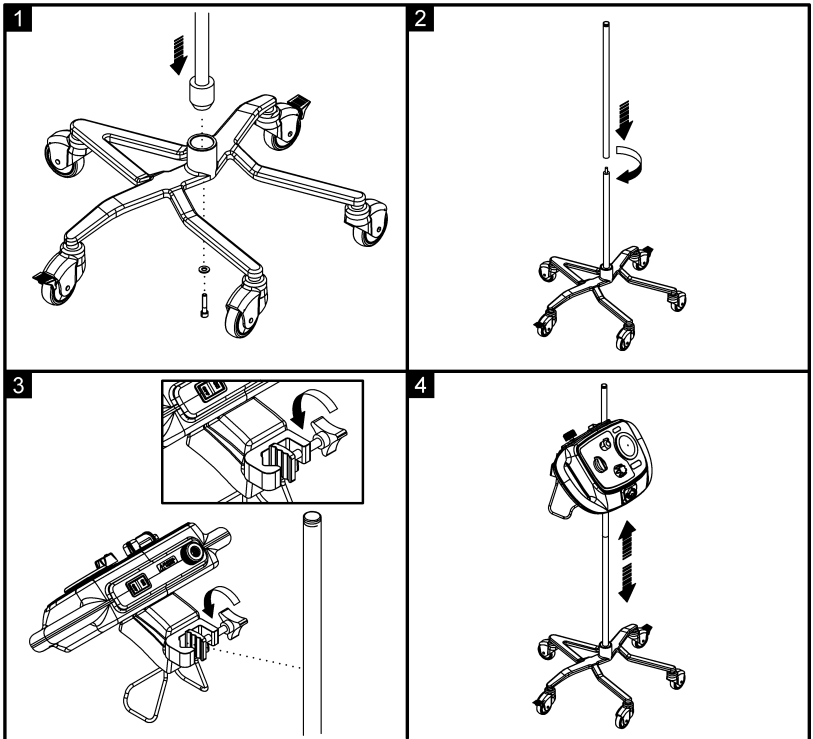

Installation of M08183 Stand

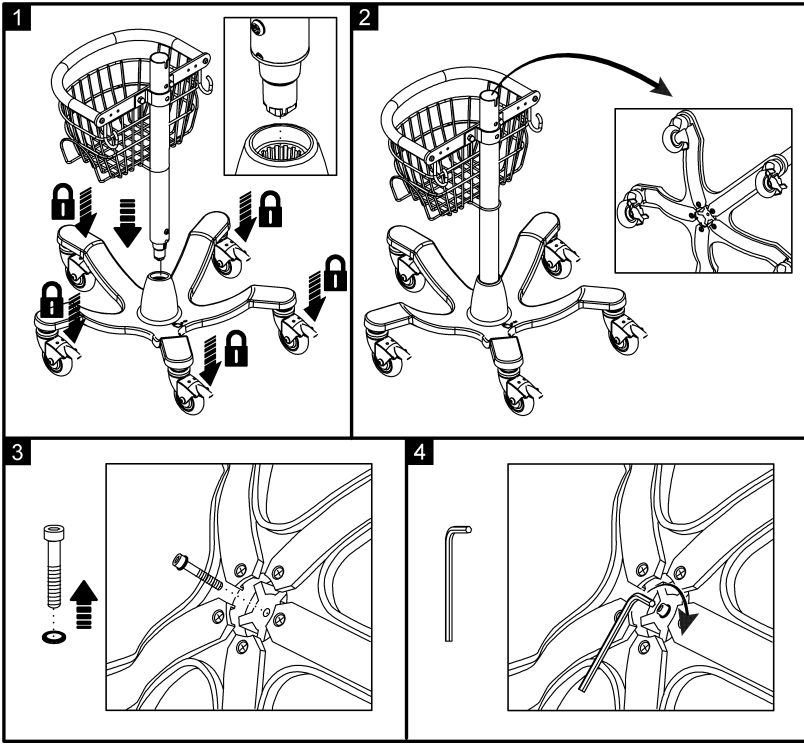

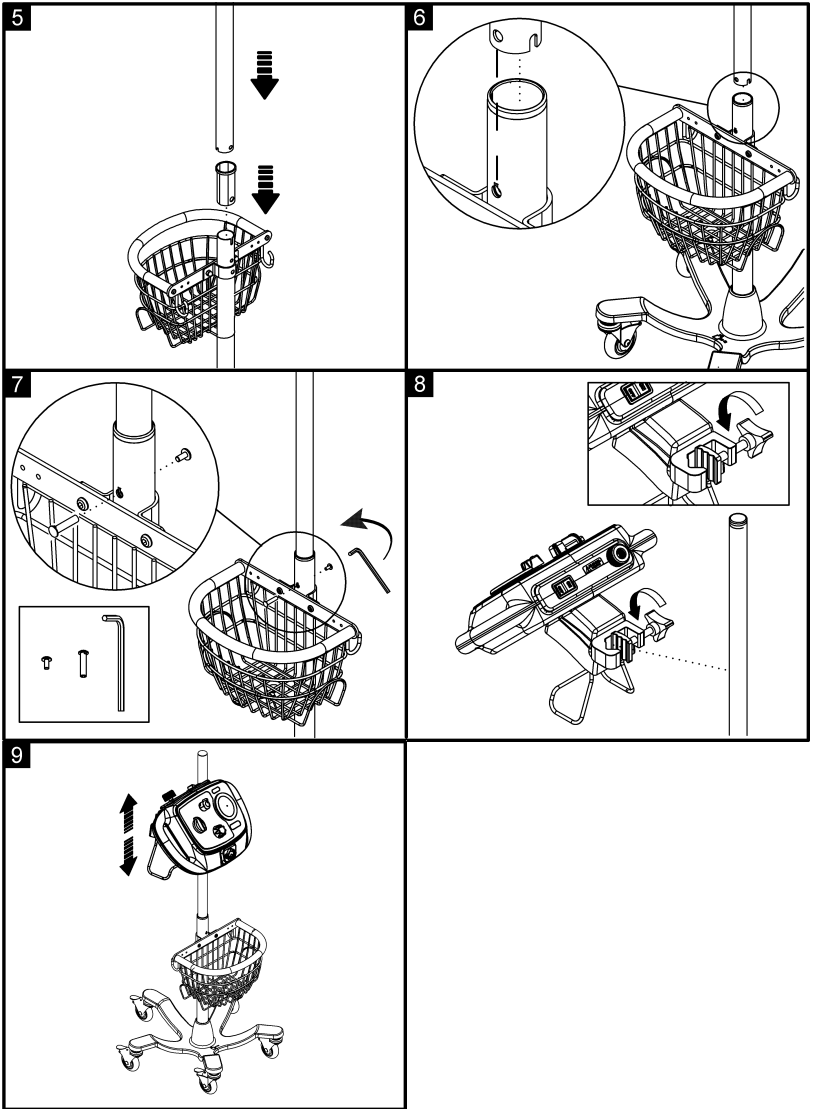

Connect the Oxygen Hose

1. Attach, and hand tighten the oxygen hose to the connector on the controller.
2. Install the applicable hose adapter on the free end of the hose, as necessary for your facility.
3. Attach, and hand tighten the free end of the oxygen hose to an oxygen source.

ASSEMBLE THE CIRCUIT

TYPICAL MOUTHPIECE CONFIGURATION

1. Connect the circuit tri-connector/bio-filter to the tri-connector port on the control unit.

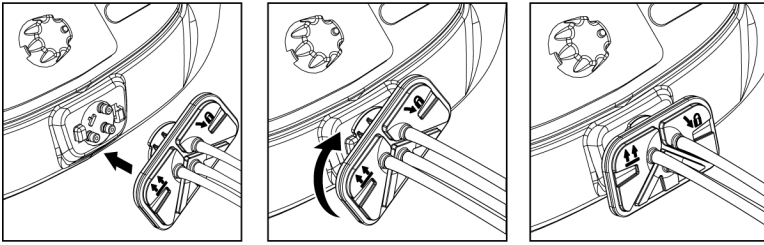

NOTES:

- Do not apply force or pull the device when it is connected to the oxygen source.
 - Do not pull the device using the circuit tubing when in use or during transportation.
2. Remove the mouthpiece from the package.
 3. Attach the mouthpiece to the handset—insert the mouthpiece at a 45° angle and gently push it in and twist it to the correct orientation.



CAUTION:

Caution—Use only with the supplied nebulizer.

4. Remove the nebulizer from the package.
5. Assemble the nebulizer and add the prescribed medication. See “Add Medication to the Nebulizer” on page 14.

NOTE:

Assemble the nebulizer before you attach it to the circuit.

6. Connect the nebulizer to the nebulizer port on the bottom of the handset.
7. Connect, but do not twist the nebulizer hose of the tubing to the bottom of the nebulizer. Make sure to push the bushing all the way on to the nebulizer stem.

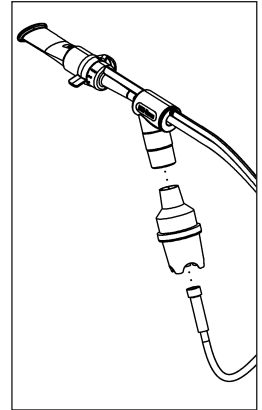

NOTE:

A twisted hose can cause the nebulizer container to become loose.

OTHER CONFIGURATIONS

Mask

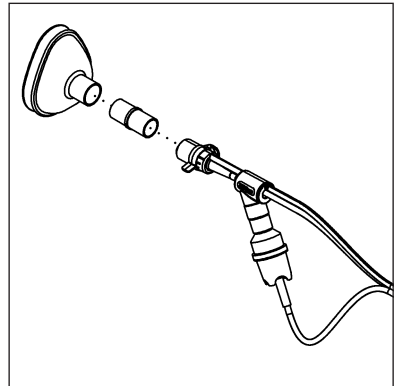

Tracheostomy

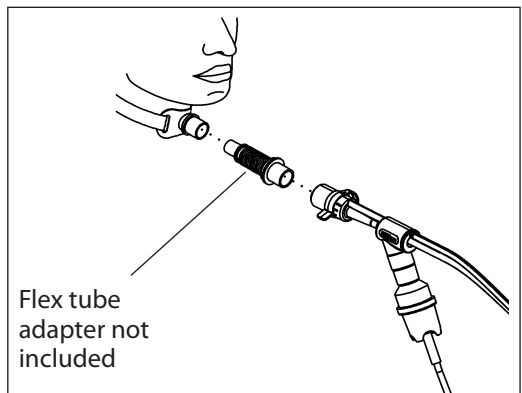

In-Line with Ventilator Circuit

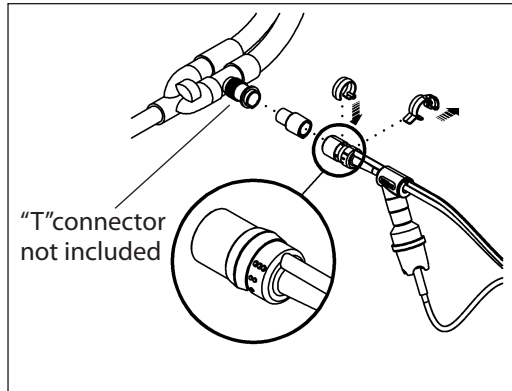

ADD MEDICATION TO THE NEBULIZER



CAUTION:

Caution—The maximum capacity of the nebulizer container is 5 mL. Do not fill the container beyond the maximum fill indication point (5 mL). To do so could cause equipment damage.

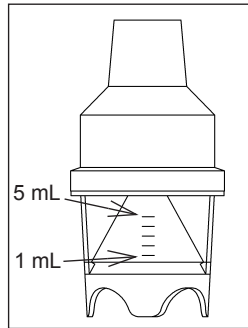

1. Remove the container cap (1) from the nebulizer.
2. If the green cone is not already installed, put the green cone (2) into the container (3).
3. Fill the container (3) with the prescribed medication. The minimum capacity of the nebulizer is 1 mL and the maximum capacity is 5 mL.

NOTE:

If there is no medication administered, use normal sterile saline to ensure the hydration of secretions.

4. Install and tighten the container cap on to the container. Make sure the green cone (2) in the container stays in position.

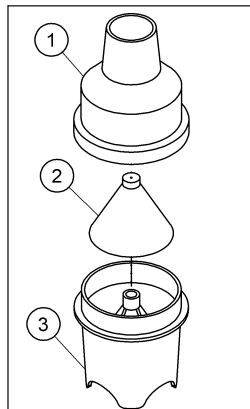

PRE-USE CHECK

Do this before each use:

1. Connect the gas hose to a 50 psi oxygen source.
2. Connect the circuit tri-connector/bio-filter to the tri-connector port on the control unit.

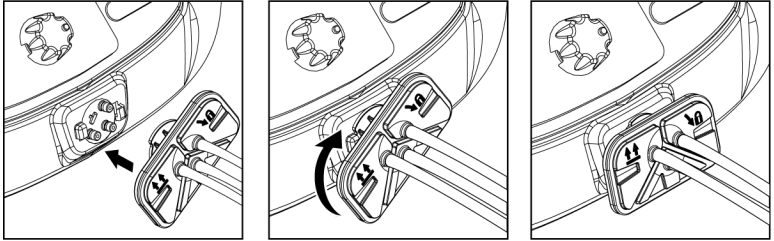

NOTES:

- Do not apply force or pull the device when it is connected to the oxygen source.
 - Do not pull the device using the circuit tubing when in use or during transportation. Set the mode to **CHFO**, and select **Higher**.
3. Set the selector ring on the handset to the **three-dots** position.
 4. Put the master switch in the **ON** position.
 5. Occlude the patient opening of the handset.
 6. Watch the pressure gauge. The average of pressure fluctuations should not be less than 15 and not more than 30 cm H₂O.
 7. Set the mode to **CPEP**.
 8. Turn the CPEP flow dial counterclockwise to **full flow**.
 9. With the selector ring on three dots, occlude the patient opening of the handset and monitor the manometer. Make sure there is a peak pressure occurrence of not less than 20 and not more than 30 cm H₂O.
 10. If the device is not within the parameters specified above, do not use the unit. Contact Hill-Rom Technical Support to examine and repair the unit.

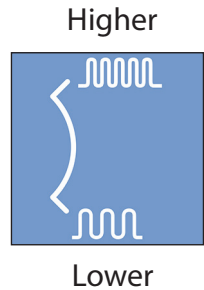

PRE-USE CHECK FOR IN-LINE USE WITH A VENTILATOR

Do this before each use:

1. Connect the gas hose to a 50 psi oxygen source.
2. Connect the circuit tri-connector/bio-filter to the tri-connector port on the control unit.

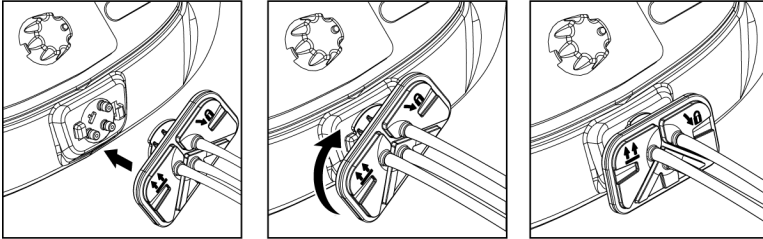

NOTES:

- Do not apply force or pull the device when it is connected to the oxygen source.
 - Do not pull the device using the circuit tubing when in use or during transportation.
3. Set the mode to **CHFO**, and select **Higher**.
 4. Put the master switch in the **ON** position.
 5. Occlude the patient opening of the handset.
 6. Watch the pressure gauge. The average of pressure fluctuations should not be less than 15 and not more than 40 cm H₂O.
 7. Set the mode to **CPEP**.
 8. Turn the CPEP flow dial counterclockwise to **full flow**.
 9. With the black occlusion ring installed, occlude the patient opening of the handset and monitor the manometer. Make sure there is a peak pressure occurrence of not less than 20 and not more than 45 cm H₂O.
 10. If the device is not within the parameters specified above, do not use the unit. Contact Hill-Rom Technical Support to examine and repair the unit.

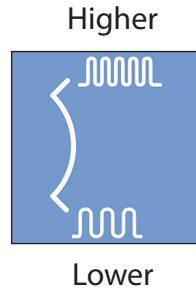

METATHERAPY® TREATMENT PROTOCOL

FREQUENCY

The common strategy for the frequency of MetaTherapy® Treatment in the acute care setting, ranges from two (2) to four (4) times daily. The patient's response to the therapy should determine any frequency adjustments.

PROCEDURE

1. Make sure the unit operates correctly. See "Pre-Use Check" on page 15.
2. Follow your institutional guidelines for infection control.
3. Introduce yourself, and explain the procedure to the patient.
4. The patient should be in an upright and comfortable position, if possible.
5. The patient should be assessed per institutional guidelines.
6. Fill the nebulizer with the prescribed medications, if applicable. See "Add Medication to the Nebulizer" on page 14.
7. Set the mode to **CPEP**.
8. Turn the CPEP flow dial all the way clockwise to the **lowest** position.
9. Set the selector ring on the handset to the **one-dot** position.
10. Connect The MetaNeb® System to an approved 50 psi oxygen source.
11. Put the master switch in the **ON** position.
12. Adjust the CPEP flow to observe the aerosol that comes from the patient end of the handset.
13. Attach the mouthpiece to the handset.

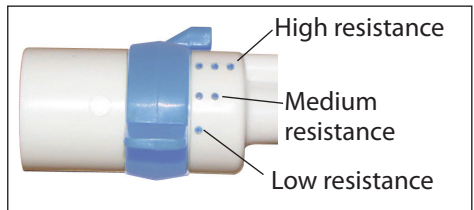

NOTE:

A cushion mask or tracheotomy tube may also be connected to the handset using the appropriate provided adapter.

14. Instruct the patient to inhale normally and exhale slowly (3-4 seconds) through the mouthpiece or facemask.
15. Adjust the selector ring up to the **two-dot** setting for higher resistance or **three-dot** setting for highest resistance as tolerated by the patient.

16. Encourage the patient to exhale slowly (3-4 seconds).
17. Continue CPEP mode for approximately 2 ½ minutes, adjusting the flow to achieve a therapy that is comfortable yet challenging for the patient or as otherwise provided in institutional protocol.
18. Instruct the patient that the mode will now change to CHFO. Proceed with changing the mode to **CHFO**.
19. Move the **Higher/Lower** switch to **Higher**.
20. During the treatment, the selector ring may be adjusted and the **Higher/Lower** switch may be moved to **Lower**.

NOTE:

The **Lower** setting on the **Higher/Lower** switch reduces the percussion rate and the pressure, and may be used as an introductory mode. Subsequently, the switch may be returned to the Higher position for enhanced therapy.

21. Encourage the patient to inhale normally and exhale slowly (3-4 seconds) against pulsations, keeping his or her cheeks firm to avoid pressure loss.
22. Continue CHFO mode for approximately 2 ½ minutes.
23. Alternate between CPEP and CHFO for 10 minutes or depending on patient need or as otherwise provided in institutional protocol.
24. When the treatment is complete, turn the unit off.
25. Disconnect the circuit, and store the unit for future use.

NOTE:

When you store the circuit, keep the tubing attached to the bottom of the nebulizer cup and disassemble the top of the nebulizer from the handset.

ASSESSMENT OF OUTCOME

Therapy will be discontinued per facility protocol or when one of these occur:

- Secretion clearance is < 5 cc per treatment for a 24 hour period.
- The post therapy chest exam shows an absence of retained secretions and atelectasis.
- Breath sounds have become clear or have improved.

RE-EVALUATION

Patients should be evaluated every 24 hours while on The MetaNeb® System to make sure that an acute change has not occurred.

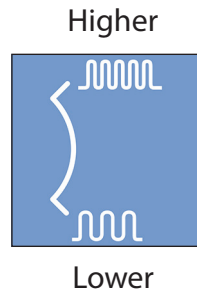

THE METANEB® SYSTEM IN-LINE WITH VENTILATOR PROTOCOL



WARNING:

Warning—Only persons trained to use The MetaNeb® System and ventilators should perform therapy on ventilated patients.

FREQUENCY

In-line use of The MetaNeb® System with a ventilator ranges in frequency from four (4) to eight (8) times daily as determined by the patient's response to the therapy.

There is no need for CPEP, as this therapy can be accomplished with the ventilator.

PROCEDURE

1. Make sure the unit operates correctly. See "Pre-Use Check" on page 15.
2. Follow your institutional guidelines for infection control.
3. Introduce yourself, and explain the procedure to the patient.
4. Make a note of the current ventilator alarm and mode settings.
5. The patient should be in a position to maintain the head of the bed angle at > 30 degrees if possible.
6. Assess the patient per institutional guidelines.
7. Prepare the handset for in-line use as follows:
 - a. Remove the selector ring from the patient end of the handset.
 - b. Install the black occlusion ring to make sure the exhalation orifice is blocked.
 - c. Use the adapter (15 mm x 22 mm) to connect the handset to the spring-valve tee adapter.
8. Fill the nebulizer with the prescribed medications as applicable. See "Add Medication to the Nebulizer" on page 14.
9. Connect The MetaNeb® System to an approved 50 psi oxygen source.
10. Set the mode to **CHFO** and select **Higher**.

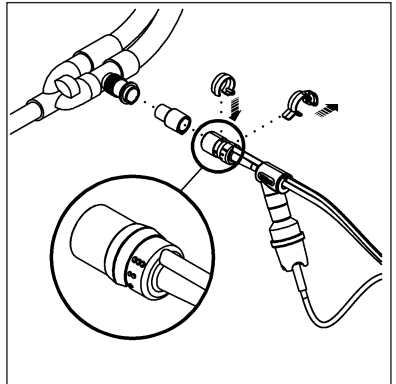

11. Put the master switch in the **ON** position.
12. Put a spring-valve "tee" adapter into the inspiratory limb of the ventilator circuit.
13. Monitor the patient response to the therapy, and continue the treatment for 10 minutes or per facility protocol.
14. Adjust the alarm parameters as necessary while The MetaNeb® System supplies in-line therapy.

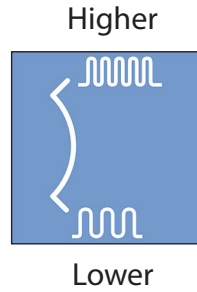

WARNING:

Warning—As secretions mobilize, it is not uncommon for plugs to momentarily occlude the upper airways. Do not leave the patient during the therapy and be prepared to suction.

15. Suction secretions as necessary during treatment.
16. Remove the handset and adapter from the spring-valve tee and cap the spring-valve tee before you put The MetaNeb® System master switch in the **OFF** position.
17. Return the ventilator alarms and mode to their previous settings.
18. Monitor and document the patient's tolerance during and after the treatment (HR, SpO₂, Bp, Auscultation, and such).
19. Store The MetaNeb® System circuit according to your institution's infection control protocol.

ASSESSMENT OF OUTCOME

Therapy will be discontinued per facility protocol or when one of these occur:

- Secretion clearance is <5 cc per treatment for a 24 hour period.
- The post therapy chest exam shows an absence of retained secretions and atelectasis.
- Breath sounds have become clear or have improved.

RE-EVALUATION

Patients should be evaluated every 24 hours while on The MetaNeb® System to make sure that an acute change has not occurred.

MOVE THE STAND

NOTES:

- Do not apply force or pull the device when it is connected to the oxygen source.
- Do not pull the device using the circuit tubing when in use or during transportation.
 1. Disconnect the oxygen hose from the facility connection, and put the hose around the hanger bracket.
 2. Unlock the two locking casters.
 3. Move the stand to the applicable location.
 4. Lock the two casters.
 5. Connect the oxygen hose to the facility connection.

CLEANING



WARNING:

To help prevent injury and/or equipment damage, obey these **warnings** and cleaning instructions:

- **Warning**—Failure to discard the SPU circuit in accordance with facility protocol could cause the spread of infection.
- **Warning**—Do not steam clean the controller, stand, or circuit.
- **Warning**—Do not expose the unit to excessive moisture.
- **Warning**—Do not use harsh cleansers, solvents, or detergents.
- **Warning**—Failure to follow the cleaner manufacturers instructions could cause equipment damage.
- **Warning**—Do not use phenolic, alcohol, quaternary ammonium chloride, or bleach solutions to clean the patient circuit. Use these solutions to clean the controller only.

The Metaneb® Controller has been tested for compatibility with these cleaning and disinfecting solutions:

Chemical Class	Active Ingredient
Phenolic	Ortho-Phenylphenol Ortho-Benzyl-para-Chlorophenol
Alcohol	Isopropyl alcohol

Chemical Class	Active Ingredient
Quaternary ammonium chloride	Didecyl Dimethyl Ammonium Chloride Alkyl Dimethyl Benzyl Ammonium Chloride
Bleach	Sodium Hypochlorite

CLEANING THE CONTROLLER AND STAND

Clean the controller and stand between patients, when visibly soiled, or according to facility protocols. Do not spray the cleaner on to the controller. We recommend that you clean the controller and stand with a soft cotton cleaning pad that is moistened with the cleaner.

Do not use excessive liquid or harsh cleansers. Do **not** immerse the controller in water or let liquids enter the controller.

Clean the controller and stand as follows:

1. Make sure the air supply hose is connected to the controller.
2. Make sure a circuit is connected.
3. Wipe down the controller or stand with the moistened cloth.
4. After you clean the controller or stand, make sure it is dry before you use it.

CLEANING THE CIRCUIT



WARNING:

To help prevent cross-contamination and/or equipment damage, obey these **warnings** and cleaning instructions:

- **Warning**—To help prevent cross-contamination, replace the SPU circuit between patients. Failure to do so could cause infection.
- **Warning**—Do not use phenolic, alcohol, quaternary ammonium chloride, or bleach solutions to clean the patient circuit. Use these solutions to clean the controller only.

If the system is shared by multiple users, replace the circuit when used between patients.

Replace the circuit if it is damaged or visibly soiled. Do **not** disinfect or sterilize the circuit for reuse by more than one patient.

The circuit is intended for a maximum of 30 treatments or 7 days of use, subjected to use by the same patient.

These cleaning instructions are for multiple usage of the circuit by a single patient. The circuit has been tested for compatibility with warm soapy

water for cleaning. The facility should follow their internal infection control policies on cleaning the nebulizer and circuit. If a policy is not in place, the following is a guideline for proper cleaning of the circuit:

1. Disconnect the circuit from the controller.
2. Discard any unused medication in accordance with facility protocol.
3. Disconnect the handset from the circuit tubing.
4. Examine the inside of the circuit tubing for dirt or liquid. If you see either of these, replace the circuit.
5. Remove the mouthpiece, adapters, and nebulizer from the handset.
6. Rinse the nebulizer cup with sterile water.
7. Wash the handset, mouthpiece, and adapters with warm soapy water.
8. Rinse the handset, mouthpiece, and adapters thoroughly.
9. Let the handset, nebulizer cup, mouthpiece, and adapters air dry **or** dry with a lint free cloth or paper towel.
10. Wipe down the outside of the circuit tubing with an approved alcohol based cleaner.
11. After all parts are dry, assemble the circuit, and put it in a breathable bag with the patient's name on it for use later.

NOTE:

Before the next use of the system, do these:

- Examine the nebulizer for cracks or other damage. If there is damage, replace the circuit. See "Circuit Part Numbers" on page 41.
- Assemble the nebulizer. See "Add Medication to the Nebulizer" on page 14.
- Do the "Pre-Use Check" on page 15.
- For units used with an in-line ventilator, do the "Pre-Use Check For In-Line Use with a Ventilator" on page 16.

TROUBLESHOOTING AND MAINTENANCE

TROUBLESHOOTING

Problem	Examine	Repair
Circuit will not connect correctly.	Examine the O-rings. Examine the connector port.	Replace the O-rings. Replace the unit if the port is damaged.
Circuit will not function.	Circuit not connected. Leak in interface tubing. O-rings worn or missing. On/Off switch position.	Disconnect the circuit, and connect it correctly. Replace the circuit. Replace the O-rings. Make sure the master switch is ON .
CHFO or CPEP therapy weak.	Connected to an approved 50 psi oxygen source. Selector ring is on the single dot setting. CPEP flow knob.	Connect to an approved 50 psi oxygen source. Turn the selector ring to the 2 or 3 dot setting for the applicable effect. Turn the CPEP knob to the applicable setting.
No pulsations/flow.	Mode, On/Off switch. Unit DISS connection.	Make sure the Mode selector switch and the On/Off switch are in the correct position. Make sure the unit is connected to an approved 50 psi oxygen source.

Problem	Examine	Repair
Nebulizer not aerosolizing correctly.	Nebulizer connection. Nebulizer is dirty.	Connect the nebulizer correctly. Clean or replace the nebulizer (see the Nebulizer package for cleaning instructions).
Manometer shows a reading even though no pressure is applied.		Adjust the manometer to zero. Refer to the service manual.

MAINTENANCE

No preventative maintenance is required for this device.

An extended warranty is available for service related maintenance and repair. The extended warranty is available for purchase during the first five years of ownership.

Units returned for maintenance and repair must be handled by Hill-Rom, and must have a return goods authorization (RGA) number.

For disposal of the controller, return it to Hill-Rom or your Hill-Rom distributor.

SHIPPING AND PACKAGING

When The MetaNeb® System controller is shipped for repair, follow these shipping and packaging instructions:









1. Request and get a return goods authorization (RGA) number from Hill-Rom.





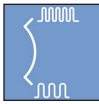



NOTE:

You will get a return kit in the mail.

2. Clean and disinfect the unit. Make sure it is dry before you pack it. See "Cleaning" on page 21.
3. Follow the instructions in the return kit to pack the unit.
4. Close and seal the box, and apply the applicable labels on the outside of the box.
5. During shipment, the unit should be kept dry and maintained at temperatures of -40° F to 158° F (-40° C to 70° C).

PRODUCT SYMBOLS

Symbol	Definition
	Consult accompanying documents.
	Continuous Positive Expiratory Pressure (CPEP) mode supplies medicated aerosol combined with continuous positive pressure to help hold open and expand the airways.
	Continuous High Frequency Oscillation (CHFO) mode is a pneumatic form of chest physiotherapy that delivers medicated aerosol while oscillating the airways with continuous pulses of positive pressure.
	Refer to the user manual.
	Aerosol mode—CHFO and CPEP are not available during this mode.
	Higher/Lower—used with CHFO.
	Flow—used with CPEP.
	Fire Hazard—keep away from ignition sources.
	This product is not manufactured with natural rubber latex.

Symbol	Definition
 YYYY-MM-DD	Manufacturer and date of manufacture
	Non-sterile product
RxOnly (USA)	By Prescription Only (USA only)
	Single patient use product
	The MetaNeb® System conforms to the European Medical Device Directive 93/42/EEC ^a . Units made before September 14, 2018.
	The MetaNeb® System conforms to the European Medical Device Directive 93/42/EEC. Units made on and after September 14, 2018.
	Authorized European Representative
	Maintain the circuit tri-connector/bio-filter in an upright position when in use.
	Turn the circuit tri-connector/bio-filter clockwise for secure fit with the control unit.
	Mass of medical equipment including the mobile stand, control unit, patient circuit, and the maximum load permitted to put in the basket.

a. The CE mark was first applied in 2014. The mark applies only to a controller (Part number 186071).

SPECIFICATIONS

Feature	Dimension
Controller (See page 30.)	
Weight	4.8 lb (2.2 kg)
Height x width x depth	10" x 15" x 4" (254 x 381 x 102 mm)
Bracket Arm	
Weight	1.2 lb (.5 kg)
Height	When attached to the standard 1" (2.5 cm) diameter pole, the height is adjustable throughout the pole length
Stand (See page 31.)	
Weight	10.6 lb (4.8 kg) (base and pole)
Height, base to top of pole	50.6" \pm 0.04" (128.5 cm \pm 1 cm)
Pole diameter	1" (2.5 cm)
Pole total length	45" (115 cm)
Base height	8.7" (22 cm) (includes casters)
Base width	23.2" (58.9 cm)
Rolling diameter	25" (63.5 cm)
Stand (See page 32.)	
Weight	22.3 lb (10.1 kg)
Height, base to top of pole	49.6" \pm 0.04" (126 cm \pm 1 cm)
Pole diameter	1.3" (32.3 cm \pm 0.5 cm)
Pole total length (including bottom cart)	42.5" (108 cm \pm 0.5 cm)
Base height	5.1" (12.9 cm) (includes casters)
Base width	19" (48.3 cm)
Rolling diameter	22" (55.9 cm)
Oxygen Supply Hose (USA only; not applicable for other countries)	
Color	Green
Length	10' (304 cm)

Feature	Dimension
Fittings	Standard DISS on each end
Single Patient Use (SPU) Circuit ^a	
Length	60" (152.4 cm)
Material	Disposable materials are not manufactured with natural latex
Power Requirements ^b	Minimum 50 psi (345kPa) with 60 L/min flow rate of hospital grade oxygen
Sound Level	< 85 dBA (during operation)

a. Single and 5 pack options are available (see "Circuit Part Numbers" on page 41).

b. The supply pressure is regulated to 50 psi (345 kPa) if a higher pressure source is connected.

CONTROLLER DIMENSIONS

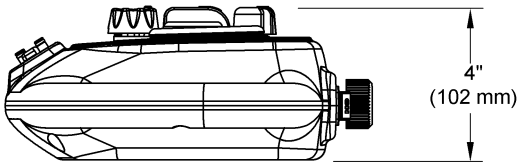
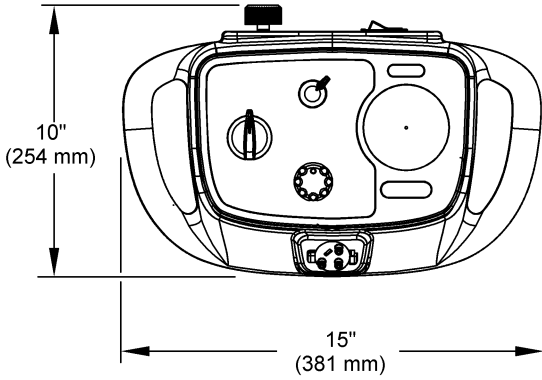

STAND DIMENSIONS (183808 and 207384)

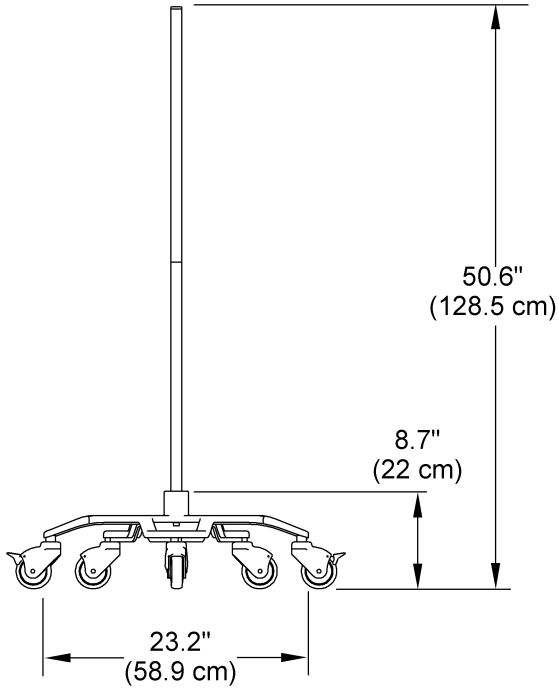

STAND DIMENSIONS (M08183)

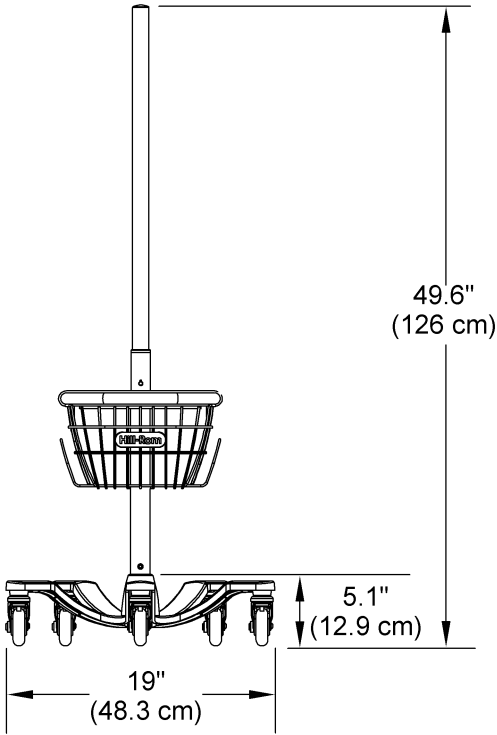

Environmental Conditions for Transport and Storage¹

Condition	Range
Temperature	-13° to 158°F (-25° to 70°C) ambient temperature
Relative humidity	Up to 90% non-condensing

Environmental Conditions for Transport and Storage with Packaging

Condition	Range
Temperature	-40° to 158°F (-40° to 70°C) ambient temperature
Relative humidity range	10% to 95% non-condensing
Atmospheric pressure	55 kPa to 106 kPa

Environmental Conditions for Use

Condition	Range
Temperature	41° to 104°F (5° to 40°C) ambient temperature
Relative humidity range	15% to 90% non-condensing
Atmospheric pressure	70 kPa to 106 kPa

CLASSIFICATION AND STANDARDS

Technical and Quality Assurance	ISO 13485 EN13544-1
FDA Medical Device Equipment Classification	Class II
Classification According to Medical Device Directive 93/42/EEC	Ila

1. These conditions and values apply to a fully-assembled MetaNeb® System.

TECHNICAL SPECIFICATION FOR PERFORMANCE—BREATHING SIMULATOR

The performance checks shown on page 35 were measured by use of a breathing simulator.



WARNING:

Warning—Due to excessive restriction of valves in the Controller, reduced performance levels may result when gas supply pressures < 50 psi (345 kPa) are used.

For these checks, we used a compressed gas supply of 50 to 55 psi (345 to 379 kPa) and the Breathing Simulator settings shown here:

Breathing Simulator Settings	
Lung Resistance	20 cm H ₂ O/l/s
Lung Compliance	50 mL/cm H ₂ O
Breath Rate	20 bpm
Effort Amplitude	25 cm H ₂ O
Target Volume	500 mL

CHFO PULSES—AIRWAY PRESSURE READING

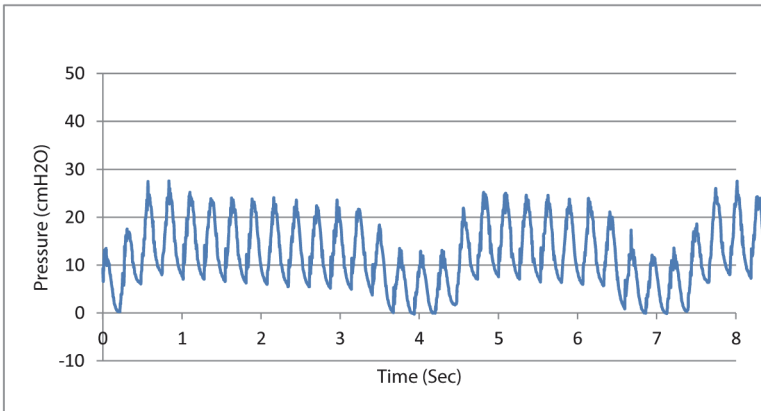

CHFO Results	
CHFO High Rate	240 ± 60 bpm (300 bpm max)
CHFO Low Rate	70% of CHFO High Rate (100 bpm min)
Peak Pressure	30 cm H ₂ O
Oscillating Amplitude	5 cm H ₂ O minimum

CPEP—AIRWAY PRESSURE READING

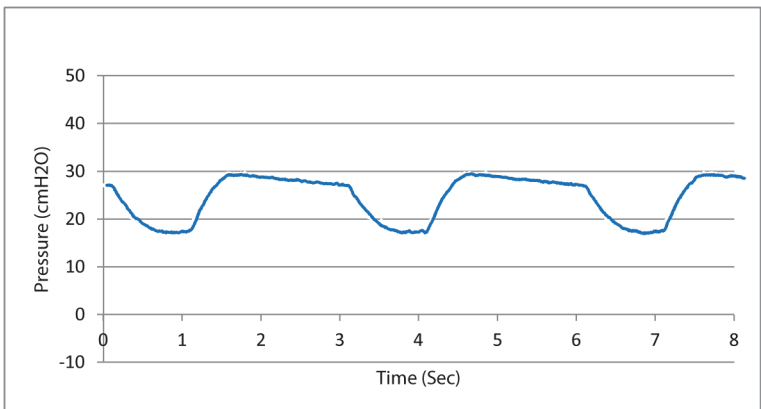

HI PRESSURE CHFO PULSES—AIRWAY PRESSURE READING

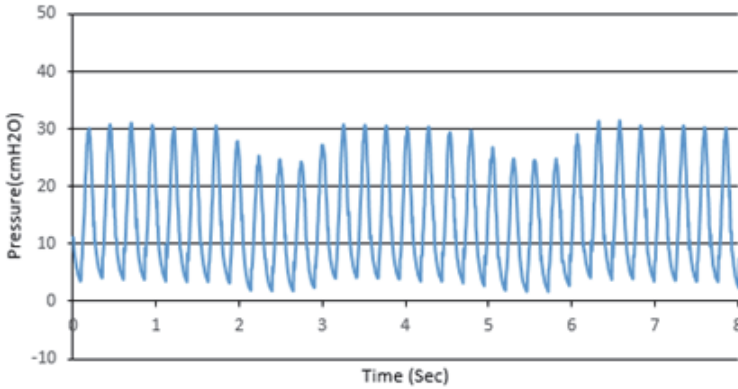

CHFO Results	
CHFO High Rate	240 ± 60 bpm (300 bpm max)
CHFO Low Rate	70% of CHFO High Rate (100 bpm min)
Peak Pressure	40 cm H ₂ O
Oscillating Amplitude	5 cm H ₂ O minimum

HI PRESSURE CPEP—AIRWAY PRESSURE READING

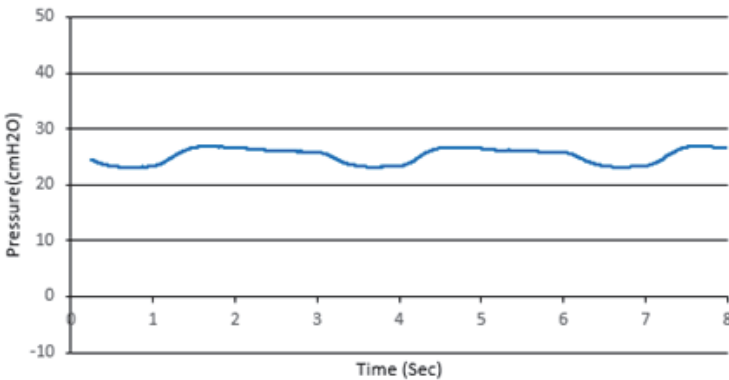

BENCH PERFORMANCE CHECKS—BREATHING SIMULATOR

The performance checks shown on page 38 through page 40 were measured by use of a breathing simulator.



WARNING:

Warning—Due to excessive restriction of valves in the Controller, reduced performance levels may result when gas supply pressures < 50 psi (345 kPa) are used.

For these checks, we used a compressed gas supply of 50 to 55 psi (345 to 379 kPa). The breathing simulator was configured with different compliance and resistance values to represent different degrees of lung health.

Adult Norm

Breathing Simulator Settings—Bench Check 1	
Lung Resistance	5 cm H ₂ O/l/s
Lung Compliance	70 mL/cm H ₂ O
Breath Rate	15 bpm
Effort Amplitude	15 cm H ₂ O
Effort Slope	18
Effort % Inhale	33
Effort Offset	0 cm H ₂ O
Target Volume	650 mL
Flow Conversion Factor	1
Time between Samples	30.1 milliseconds
Number of Samples	400

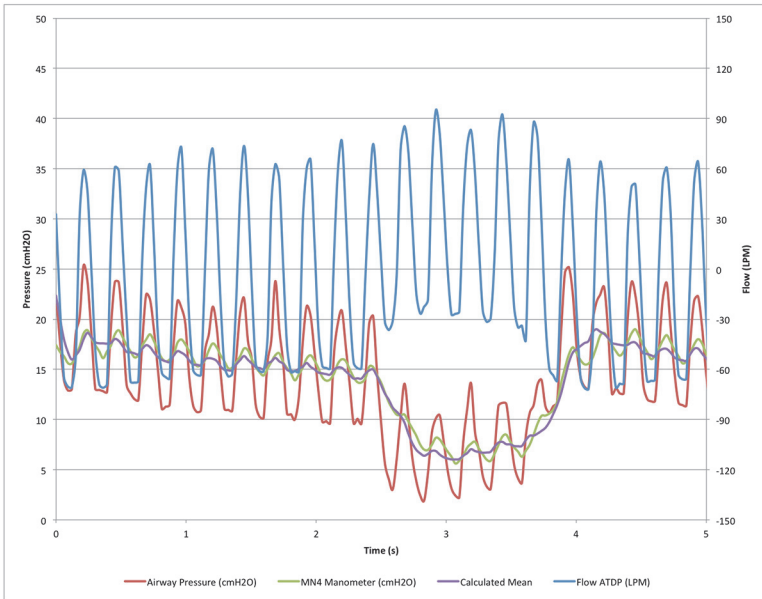

Adult Obstructive

Breathing Simulator Settings—Bench Check 2	
Lung Resistance	5 cm H ₂ O/l/s
Lung Compliance	90 mL/cm H ₂ O
Breath Rate	15 bpm
Effort Amplitude	15 cm H ₂ O
Effort Slope	18
Effort % Inhale	33
Effort Offset	0 cm H ₂ O
Target Volume	650 mL
Flow Conversion Factor	1
Time between Samples	30.1 milliseconds
Number of Samples	400

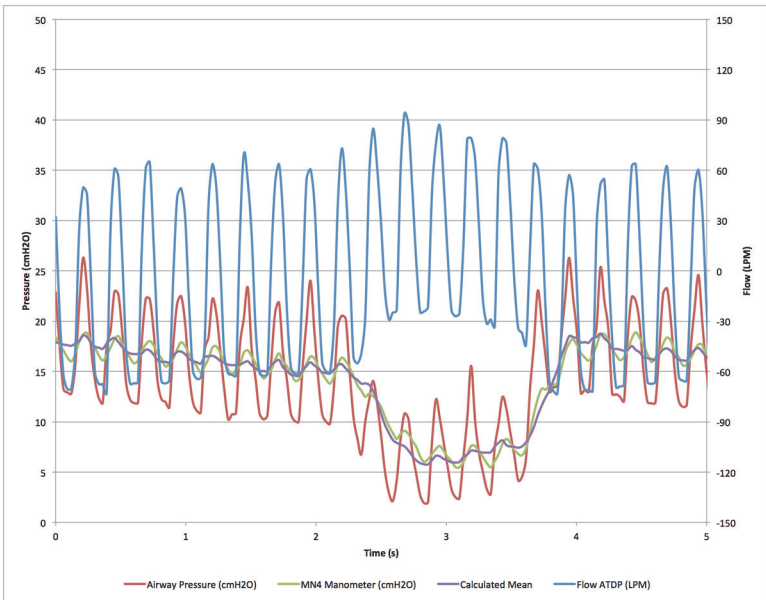

Adult Restrictive

Breathing Simulator Settings—Bench Check 3	
Lung Resistance	30 cm H ₂ O/l/s
Lung Compliance	25 mL/cm H ₂ O
Breath Rate	15 bpm
Effort Amplitude	15 cm H ₂ O
Effort Slope	18
Effort % Inhale	33
Effort Offset	0 cm H ₂ O
Target Volume	650 mL
Flow Conversion Factor	1
Time between Samples	30.1 milliseconds
Number of Samples	400

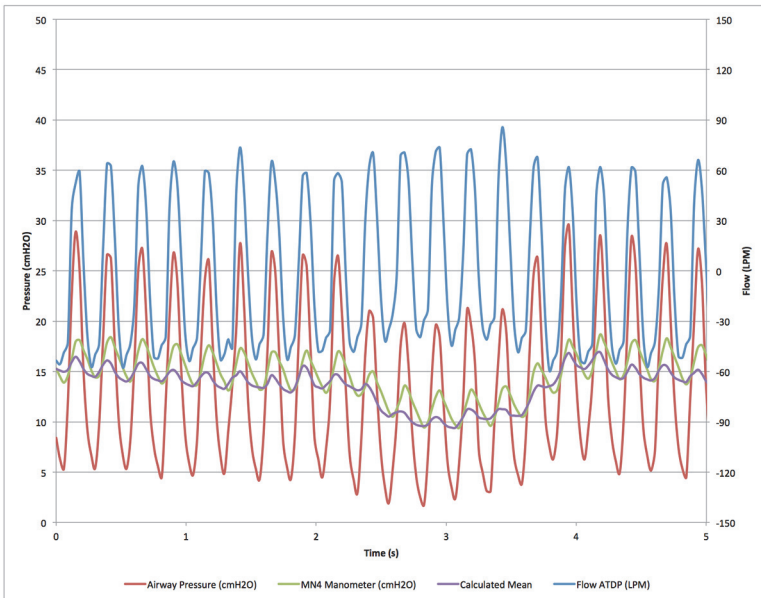

NEBULIZER PERFORMANCE

As per EN13544-1:

- Aerosol output rate: 0.08 mL/min
- Aerosol output: 0.16 mL emitted of 2.0 mL

NOTE:

The performance of the nebulizer may differ from that shown below. The performance is dependent on the type of drug and nebulizer unit that is used. For more information, contact Hill-Rom, your distributor, or the drug supplier.

The performance data shown below may not be applicable for suspensions or medications with a high viscosity.

Representative Particle Size Distribution per EN13544-1

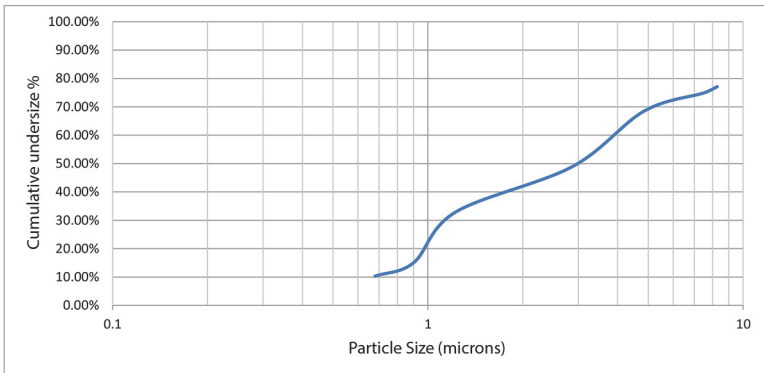

CIRCUIT PART NUMBERS

Part Number	Description
C20000N	Circuit, SPU With Nebulizer, Single Kit
PC20005N	Circuit, SPU With Nebulizer, 5 Kit

PARTICLE SPECIFICATIONS

The following specifications were established through performance tests using an eight-stage cascade impactor at a flow rate of 28 liters per minute (LPM) equipped with a USP <601> induction port throat. Three device samples were tested with three runs each for a total of nine sample points per each drug for a total of 27 data points. Aerosol was sampled directly from the outlet.

Aerosol Only Mode at 28 LPM Particle Specifications with 95% Confidence Level

Particle Characterization	Drug	MetaNeb
MMAD (um)	Albuterol Ipratropium Cromolyn	0.98-1.28 0.81-1.20 0.83-1.19
GSD		2.65-3.05 2.5-3.81 2.17-3.42
Total Dose Delivered by Device ug		735.5-890.6 149.2-187 2567.6-3046.6
Total Respirable Dose (0.5 - 5 um)		328.4-445.8 38.1-76.4 1554.4-1949.7
Coarse Particle Dose >4.7 microns - ug		273.9-338.2 76-101.3 381.4-521.2
Fine Particle Dose <4.7 microns - ug		427-587 59-99.9 2126.9-2584.7
Ultra-Fine Particle Dose <1.0 Microns - ug		209.5-313.4 34.7-52 1032.1-1489.1

NOTE:

Coarse particles (due to oro-pharyngeal deposition) and ultra-fine particles (due to exhalation) are not likely to deposit in the patient's airway and provide limited clinical benefit.

CHFO Mode at 28 LPM
Particle Specifications with 95% Confidence Level for 1 Cycle

Particle Characterization	Drug	MetaNeb
MMAD (um)	Albuterol Ipratropium Cromolyn	0.83-1.19 0.51-1.00 0.59-0.85
GSD		2.79-3.75 2.76-4.01 2.55-3.335
Total Dose Delivered by Device ug		421.6-572.4 124.5-204.6 1367.9-1903.9
Total Respirable Dose (0.5 - 5 um)		139.2-200.2 27-54.6 673.6-948.1
Coarse Particle Dose >4.7 microns - ug		186.8-317 60.3-126.5 199.8-266.9
Fine Particle Dose <4.7 microns - ug		213-277.1 54.1-88.3 1138.5-1666.6
Ultra-Fine Particle Dose <1.0 Microns - ug		113.3-178.3 35.2-58.5 720.5-1153.5

NOTE:

Coarse particles (due to oro-pharyngeal deposition) and ultra-fine particles (due to exhalation) are not likely to deposit in the patient's airway and provide limited clinical benefit.

CPEP Mode at 28 LPM
Particle Specifications with 95% Confidence Level for 1 Cycle

Particle Characterization	Drug	MetaNeb
MMAD (um)	Albuterol Ipratropium Cromolyn	0.71-1.12 0.33-0.83 0.27-0.44
GSD		3.99-4.76 3.23-6.93 3.77-5.04
Total Dose Delivered by Device ug		389.6-529 149-180.1 647.5-929.9
Total Respirable Dose (0.5 - 5 um)		89-137.8 16.6-46.4 208-299.2
Coarse Particle Dose >4.7 microns - ug		205.7-338.6 87.8-119 122.4-150
Fine Particle Dose <4.7 microns - ug		146.7-227.6 47.5-74.8 514.3-790.7
Ultra-Fine Particle Dose <1.0 Microns - ug		84.4-143.9 30-47.3 307.4-673.4

NOTE:

Coarse particles (due to oro-pharyngeal deposition) and ultra-fine particles (due to exhalation) are not likely to deposit in the patient's airway and provide limited clinical benefit.

Hill-Rom
